



TM8 On-Line Gas Chromatography DGA Monitor Site Preparation Guide Model TMx Series

June, 2017

Document ID: 810-1647-03 Rev B



Information in this document is subject to change without notice. This document is provided to purchasers of Serveron® products for use in the installation, operation and servicing of such products. No other use, nor any reproduction, distribution or the making of any derivatives of this document is authorized, without the express prior written permission of Serveron® Corporation.

Serveron® endeavors to ensure the accuracy and quality of its published materials; however, no warranty, expressed or implied, is provided. Serveron® disclaims any responsibility or liability for any direct or indirect damages resulting from the use of the information in this manual or products described in it. Mention of any product or brand does not constitute an endorsement by Serveron® of that product or brand.

This document was originally composed in English and was subsequently translated into other languages. The fidelity of subsequent translations cannot be guaranteed. In case of conflict between the English version and another language version, the English version takes precedence.

© 2017 Serveron® Corporation. All rights reserved. Information subject to change without notice.

QUALITROL is a registered trademark of Qualitrol Company LLC. Serveron, LOADGUIDE, and TRUEGAS are registered trademarks and TM1, TM2, TM3 and TM8 are trademarks of Serveron® Corporation.

All trademarks are properties of their respective companies, as noted herein. 810-1647-03 Rev B.



Contents

Customer Information	1
Contact Information	1
Transformer Information.....	2
Transformer Oil	2
Desired Photographs	2
Product Overview	3
Environmental Conditions	4
Site Preparation Procedure	4
Installation Overview	5
Choosing an Oil Supply and Return Port	6
Oil Supply Port	6
Oil Return Port / Bleed Fixture	7
Choosing a Mounting Location	8
Mounting Stand	9
Mounting the Stand to a Concrete Pad.....	9
Mounting to the Transformer or Wall	9
Providing Power	10
Grounding	10
LoadGuide (optional)	10
Oil Moisture and Temperature (optional)	10
Communication Interface & Protocol	11



Helium	12
Ordering Helium	12
Helium Specifications	12
Helium Suppliers	13
Stainless Steel Tubing and Fittings.....	14
Tubing Specification and Ordering Information.....	14
Tubing Suppliers	14
Site Checklist	15
DGA Monitor Dimensions	16
Concrete Pad Layout (if required)	17
Shipping Container Information.....	18
Wiring Termination	19



Customer Information

In order to facilitate installation of your monitor, please fill out the following customer information form and fax or e-mail it to:

mail: Serveron Corporation
 Attn: Customer Support
 20325 NW Von Neumann Dr., Suite 120
 Beaverton, OR 97006 USA

fax: +1 (503) 924-3290

e-mail: support@serveron.com

Contact Information

Company							
Installation Site							
Site Address							
City		State		Zip		Country	

Primary Contact							
Title							
Address							
City		State		Zip		Country	
Phone			Mobile			Pager	
Fax			Email				

Secondary Contact							
Title							
Address							
City		State		Zip		Country	
Phone			Mobile			Pager	
Fax			Email				

Table 1: Customer Information Form



Transformer Information

Make: _____ Type: _____
 Year: _____ Years in Service: _____
 kVA Rating: _____ kV Rating: _____
 conservator nitrogen blanketed other: _____
 attach all available DGA data

Table 2: Transformer Information Form

Transformer Oil

Manufacturer: _____ Type: _____
 Certified PCB free: yes / no

Table 3: Transformer Oil Information Form

Desired Photographs

Attach photographs of the following items and illustrate them in the space provided:

Oil Supply Port Note thread size and units of measure: _____
 Oil Return Port Note thread size and units of measure: _____
 Control Panel
 Mounting location of monitor

Table 4: Desired Photographs Checklist



Product Overview

The TM8 On-Line Gas Chromatography DGA Monitor from Serveron Corp. is a remotely-deployed laboratory-grade gas chromatograph which can be safely installed onto an energized or non-energized transformer. The monitor is designed to detect and measure fault gases found in an electrical power transformer's insulating oil. It is designed and constructed to resist environmental conditions relevant to a transformer substation.

Serveron offers two versions of the TMx product. The TM8 measures eight IEEE-recommended fault gases: hydrogen (H₂), oxygen (O₂), carbon dioxide (CO₂), carbon monoxide (CO), methane (CH₄), ethylene (C₂H₄), ethane (C₂H₆), and acetylene (C₂H₂). The TM3 measures the three Duval Triangle fault gases: methane (CH₄), ethylene (C₂H₄), and acetylene (C₂H₂). The monitor may be used on conservator or nitrogen-blanketed transformers. The sample of gas is extracted directly from the oil within the transformer.

Oil is circulated from transformer, to the monitor and then returned to the transformer through 1/4-inch O.D. stainless-steel tubing. Stainless-steel tubing is used in conjunction with compression fittings to minimize the risk of leaks. The monitor is equipped with an internal gas extraction system which removes dissolved gases from the circulating transformer oil. Helium is used as a carrier gas to help transport the extracted sample gases through the gas chromatograph. The oil circulation and gas extraction paths in the monitor are shown below.

Data is collected in the monitor each time a gas chromatograph (GC) analysis is completed. The GC analysis takes approximately 45 minutes. Once an analysis has been completed, the TM View software can be used to view the monitor's data. The monitor is set up to perform a sample analysis once every four hours by default. All data captured during an analysis is stored on compact flash memory within the monitor. The compact flash memory holds approximately (2) years of data. The TM View software will allow the end user to track the gas ppm levels over time and monitor the gas levels against user defined caution and alarm settings.

Optional LoadGuide® and Oil Moisture and Temperature sensors are available, along with 4-20mA inputs for use with other external devices. External sensor information can be correlated with fault gas information to allow a complete diagnostic overview of the transformer's condition.



Environmental Conditions

The TMx series is designed to operate within the following outdoor conditions:

Altitude 4572 m

Humidity Range 5% to 95%

Temperature Range -50C to 55C

Installation Category II

Pollution Degree 2

Please note that the altitude, humidity and temperature ranges indicated are considered extended environmental conditions from the minimum ranges required by UL 61010-1, Clause 1.4.1.

Site Preparation Procedure

Site Preparation consists of completing the following steps:

- Choosing an oil supply and return port
- Choosing a mounting location
- Providing power
- Choosing a communication interface & protocol (optional)
- Communication/Power/Sensor Cable Connections
- Ordering Helium
- Ordering stainless-steel tubing
- Site Checklist



Installation Overview

- | | | | |
|---|---|---|---|
| A | Existing Xfmer valve | H | Serveron Bleed Fixture Assy |
| B | <i>Customer Supplied - 2" NPT Nipple</i> | I | Serveron In-line Oil filter |
| C | Serveron Oil Supply Valve Assy | J | Existing Xfmer valve |
| D | Serveron Optional Moisture / Temperature Sensor | K | <i>Customer Supplied - Helium Cylinder, 99.9995%,</i> |
| E | <i>Customer Supplied - 1/4" SS /316 Tubing, .035 wall</i> | L | <i>Customer Supplied - 120/230 VAC, 6A/3A</i> |
| F | Serveron Secondary Shut-off / Manual Sample Valve | M | Serveron Pedestal Mounting Stand |
| G | Serveron Oil Return Assy | N | Serveron Helium Regulator |

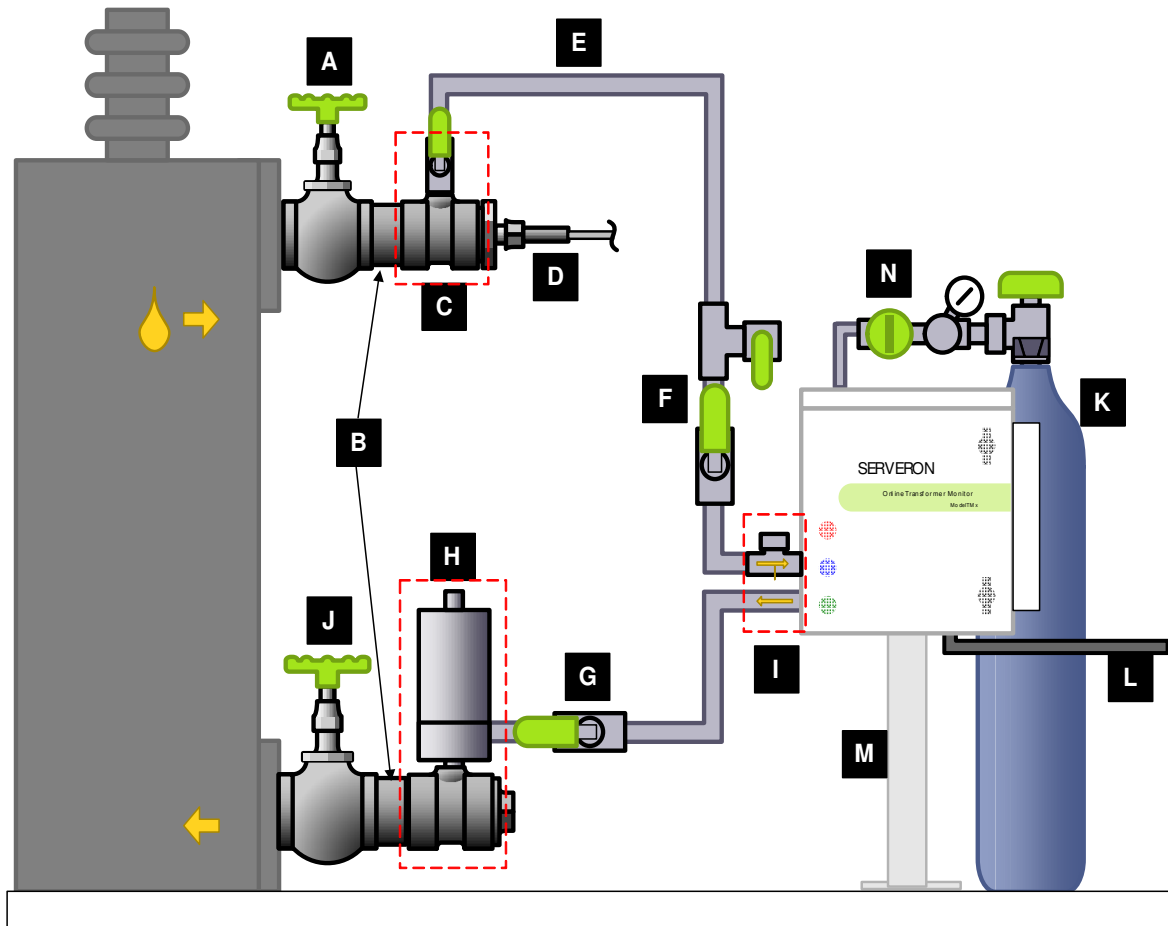

Figure 1: Installation Schematic



Choosing an Oil Supply and Return Port

The monitor circulates oil from the transformer, extracts the gases from the oil and then returns the oil to the transformer. The locations chosen for the oil supply port and oil return port are vital for the accurate analysis of the gases within your transformer.

Typically, oil is removed at the top of the transformer and returned to the bottom of the transformer. The location of the oil supply port should produce a sample that is a well-mixed representation of the transformer oil. In this section, we will discuss how to select the locations and what fittings are required.



CAUTION: Maximum Oil Inlet Pressure to the monitor is 45 psi (3 bar)

Oil Supply Port

An Oil Supply Assy (PN 456-0026-XX) is provided with the monitor. The assembly consists of a 2" black iron tee, 2" x 1/2" reducing bushing, 1/2" plug, 1/2" ball valve and a 1/2" NPT x 1/4" Tube fitting (**fig 2**). The assembly is integral to the installation and commissioning process to help remove air and prevent bubbles from entering the transformer tank when the transformer oil supply port is opened.



NOTE: Serveron recommends a minimum size of 1/2" for the oil supply valve.

Serveron does not recommend sampling oil from cooling loops or pressurized oil passages; doing so may affect the monitor operation.

It is important to sample oil from a location on the tank where the oil is circulating in order to provide a well-mixed representation of oil within the transformer. Typically, a top tank valve is used for the oil supply. For nitrogen-blanketed transformers, the oil supply port must be at least 6" below the transformer's oil level at all times. Otherwise, the oil supply must be located on a lower valve on the transformer. If the optional Oil Moisture and Temperature sensor is to be installed, it should be located on the oil supply port.



NOTE: For tubing runs that will exceed 40-ft, 3/8" tubing should be used instead of 1/4".

- Select an appropriate oil supply port on the transformer.
- Purchase the necessary nipple to mount the 2" Oil Supply Assy, **PN 456-0026-XX**.



Note: Depending on the Oil Supply Port valve size, alternate-sized fittings can be used instead of using the 2" assembly provided. If alternate-sized fittings are used for the transformer valve, they must be black iron, brass or stainless steel and the street side to the tee should be 1/2" NPT. If black iron is used, it may be beneficial to paint the valve assemblies after installation to prevent any corrosion / rust.



Install nipple and reducing bushing as required to the oil supply port using Teflon tape or pipe dope.

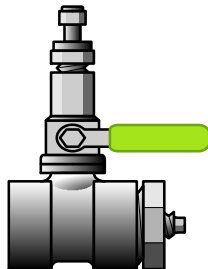

Figure 2: Oil Supply Port Assy



NOTE: It is important for the street side of the tee be oriented in the vertical direction.

Oil Return Port / Bleed Fixture

Typically, the bottom drain valve is used for the oil return port. The return port should not be located on the transformer cooling system or any pressurized oil passage. An air bleed fixture and bubble trap is required at the oil return port to allow for air removal during commissioning of the monitor. This fixture is referred to as a “Bleed Fixture“. The Bleed Fixture assembly is included with the TM monitor.



NOTE: Serveron does not recommend sampling oil from cooling loops or pressurized oil passages; doing so may affect the monitor’s operation and void the warranty.

- Select an appropriate oil return port on the transformer.
- Determine the thread size of the selected oil return port.
- Acquire necessary fittings to attach the bleed fixture to the oil return port.



NOTE: The Serveron Bleed Fixture is designed to fit on a 2” NPT nipple. When using the Serveron Bleed Fixture, adapt the oil return port to accommodate a 2” NPT female thread.



Figure 3: Installed Bleed Fixture

Choosing a Mounting Location

The monitor should be located in a position where it will not interfere with transformer maintenance or access requirements. The front of the monitor must be accessible for commissioning and maintenance. The location should also minimize the supply and return tubing runs. There are two mounting types for the TMx monitors; pedestal mounting stand or transformer tank-mounting kit.

Items to consider when choosing a location for the monitor are:

- Location of oil supply and oil return ports
- Location of power supply
- Transformer maintenance points
- Access to the monitor
- Mounting of the monitor stand



NOTE: The monitor must be mounted and operated in an upright position. Failure to do so will void the warranty.



Mounting Stand

The mounting stand is a pedestal style, requiring some assembly, and is intended to be secured to a concrete pad. The hardware required for assembly and fastening to the concrete pad is included. **Figure 4** below illustrates a typical pedestal mounting. See **figures 5** and **6** for monitor and concrete pad layout dimensions. For stand assembly, refer to the TMx Installation Guide (**810-1644-XX**).

Mounting the Stand to a Concrete Pad

- Position the stand in the predetermined mounting location.
- Using the stand as a template, mark four holes on the concrete pad.
- Remove the stand and drill four 3/8" holes in the marked locations, 3" deep.
- Insert the four 3/8-inch concrete anchors included with the stand into the holes.
- Position the stand over the four mounting bolts and secure the stand, checking to make sure the stand is plumb and level.
- Tighten retaining nuts onto the concrete anchors.



Figure 4: Pedestal Mount

Mounting to the Transformer or Wall

The transformer mounting kit includes the necessary hardware to mount the monitor and helium cylinder to unistrut. Serveron recommends using 1 5/8-inch deep-channel unistrut to mount the monitor and its components. Two 4-foot lengths of unistrut are included.

The bottom rung of unistrut must be mounted a minimum of 40-inches above grade if the helium cylinder **will** be secured to the unistrut and a minimum of 12-inches above grade or water threat if helium **will not** be secured to the unistrut.

- Secure the bottom unistrut rung in the predetermined mounting location in accordance with the appropriate height suggested above.
- Measure up from the center of the bottom rung **19.85**-inches and mark the mounting location for the second rung.
- Secure the top unistrut rung.



Providing Power

The monitor utilizes an auto-switching AC power supply and surge protector capable of utilizing 115 or 230 VAC \pm 15% (50/60Hz); 6A max. @ 115 V; 3A max @ 230V.



NOTE: Serveron recommends installing a properly rated and marked switch or circuit breaker in close proximity to the monitor as a mains voltage disconnect device.

Grounding

It is important that a proper ground is attached to the mounting structure, ensuring the monitor enclosure is grounded. (I.E., the unistrut rungs of the pedestal pole mount or the transformer mount).

LoadGuide (optional)

The optional LoadGuide sensor can be used to correlate transformer load to transformer gassing. The LoadGuide sensor consists of a current clamp that is placed over a 0 to 5 A high or low side CT. It is important that the CT give a good representation of total transformer load. Transformer load will be displayed on a relative scale with 0% indicating no load and 100% indicating full load. The standard cable length is 20-ft. Additional cable of 22 AWG or larger can be added to the LoadGuide sensor cable if required.

Oil Moisture and Temperature (optional)

An optional sensor is available to provide oil moisture in parts per million (ppm) or as percent relative saturation (%RS) and oil temperature ($^{\circ}$ C). Depending on the location of the sensor, the oil temperature can be representative of top oil temperature. It is recommended that the Oil Moisture and Temperature Sensor be installed on the oil supply valve.



Communication Interface & Protocol

The monitor offers a range of communication options. It can communicate over multiple interfaces simultaneously (but only one SCADA protocol at a time). The different communication options are as follows:

Internal Dial-up Modem (optional)- connects to any standard analog phone line (POTS).

RS-232 - (TMCOM1) connection is provided to allow serial communications with an external computer as well as interface to a cellular or external modem.

RS-485 - (TMCOM2) connection is provided.

Ethernet - The monitor is supplied with a fiber interface. A copper interface can be purchased using Serveron PN **700-0052-XX**.

Modbus or DNP3 - connection can be configured over all hardware interfaces including Ethernet, RS-232, RS-485 and modem. For more information regarding these protocols, please contact Serveron Technical Support.

IEC61850 – Can only be configured over an Ethernet interface.



Helium

The helium cylinder should be securely mounted to the monitor mounting stand or some other permanent surface. A mounting bracket that meets all compressed gas cylinder restraining requirements is provided. Serveron also provides the necessary 1/8-inch O.D. stainless-steel tubing to connect the helium cylinder to the monitor.

Ordering Helium

Helium carrier gas is vital to the performance of the chromatograph within the monitor. Using helium that does not meet the described specifications will substantially reduce the life of the monitor.

Helium Specifications

Helium Specification:	$\geq 99.9995\%$ pure, Chromatographic or Research Grade $\leq 0.5\text{ppm H}_2\text{O}$
Cylinder Size:	49.6-liter water capacity 9 inches x 60 inches including cap
Depending on vendor, cylinder size is indicated by:	300, 049, 49, 1L, A, K, T or UT
Cylinder Material:	High-pressure steel
Cylinder Valve Type:	CGA 580 (standard)

Table 5: Helium Specification and Ordering Information



NOTE: Use of helium other than pure research or chromatographic grade ($\geq 99.9995\%$ purity and $\leq 0.5\text{ ppm H}_2\text{O}$) will greatly decrease the life of the monitor components.



Helium Suppliers



		www.praxair.com
When ordering, please specify part number HE 6.0 RS – T. (US Only)		
	(971) 224-2525	www.airgas.com
When ordering, please specify part number HER – 300-CT. (US Only)		
	602-273-2636	www.airliquide.com
When ordering, please specify part number 628-49-261 SCF/CYL. (US only)		

Table 6: Helium Suppliers



Stainless Steel Tubing and Fittings

Stainless-steel tubing is used to connect the monitor to the transformer for circulating the transformer oil. The amount of tubing required depends on the location of the monitor relative to the valves on the transformer.



NOTE: Stainless-steel is the only recommended tubing material.

It is recommended that the tubing between the transformer and the monitor be installed as one continuous piece if possible, reducing the possibility of oil leaks.

Considerations to keep in mind when choosing where to route the tubing to the monitor:

- Make sure tubing will not interfere with regular maintenance of the transformer.
- Avoid long, unsupported tubing runs.
- Route tubing so that it will not be tripped over or damaged by activities near the transformer.
- If the length of the oil supply or return path exceeds 10ft, a stainless steel union will be required.
- It is recommended that your tubing be secured every 2 - 4 ft, using cable ties or other adequate clamps.

Carefully measure the predetermined tubing route from the transformer oil supply and return ports to the monitor. **If either tubing length will exceed 40ft, 3/8” tubing should be used.**

Tubing Specification and Ordering Information

Specification:	1/4-inch (3/8” as required) OD x 0.035” wall T316 seamless steel tubing.
Order Information:	Purchase in 20-foot lengths (recommended)

Table 7: Tubing Specification and Ordering Information

Tubing Suppliers

		www.swagelok.com
See website for local sales contact number		

Table 8: Tubing Suppliers



Site Checklist

Ensure that all the following steps have been completed.

- Customer Information form filled out and returned to Serveron (if applicable)
- A location for mounting the monitor has been identified and the monitor mounting stand is secured in place.
- The transformer oil supply valve and the transformer oil return valve have been selected.
- Power is available at the installation site for the monitor.
- Communication is available to the monitor, if required.
- A cylinder of chromatographic grade helium ($\geq 99.9995\%$ purity with ≤ 0.5 ppm of H₂O) is on site.
- A 0 to 5 Amp CT has been identified for the LoadGuide sensor (if LoadGuide will be installed).
- All shipped items and optional accessories have been located.
- Any additional required electrical conduit and enclosures have been installed
- 1/4" (or 3/8" as required) **0.035** wall thickness 316-SS tubing, 10 or 20-ft lengths onsite, enough for each tubing run.



DGA Monitor Dimensions

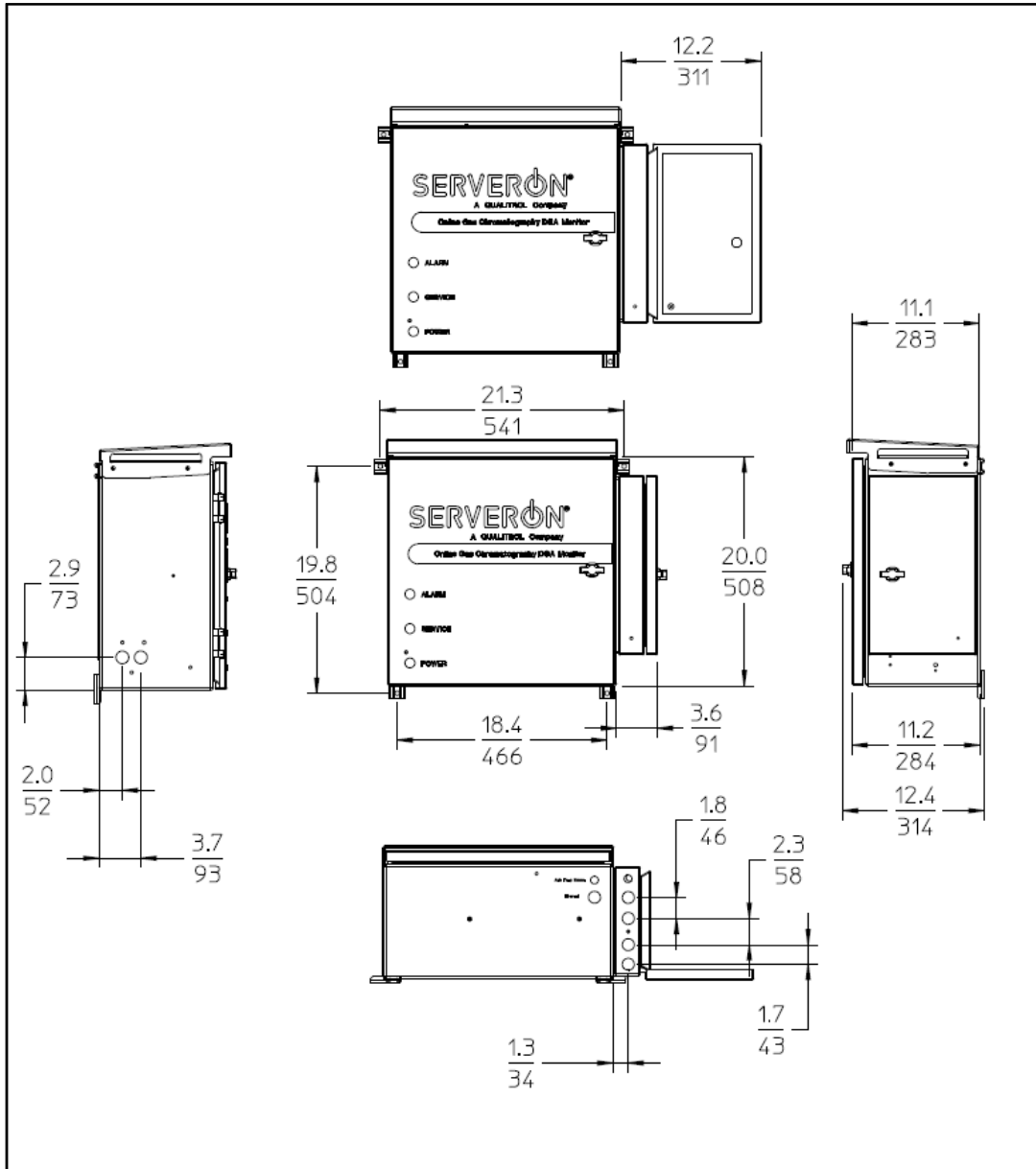

Figure 5: Monitor Dimensions



Concrete Pad Layout (if required)

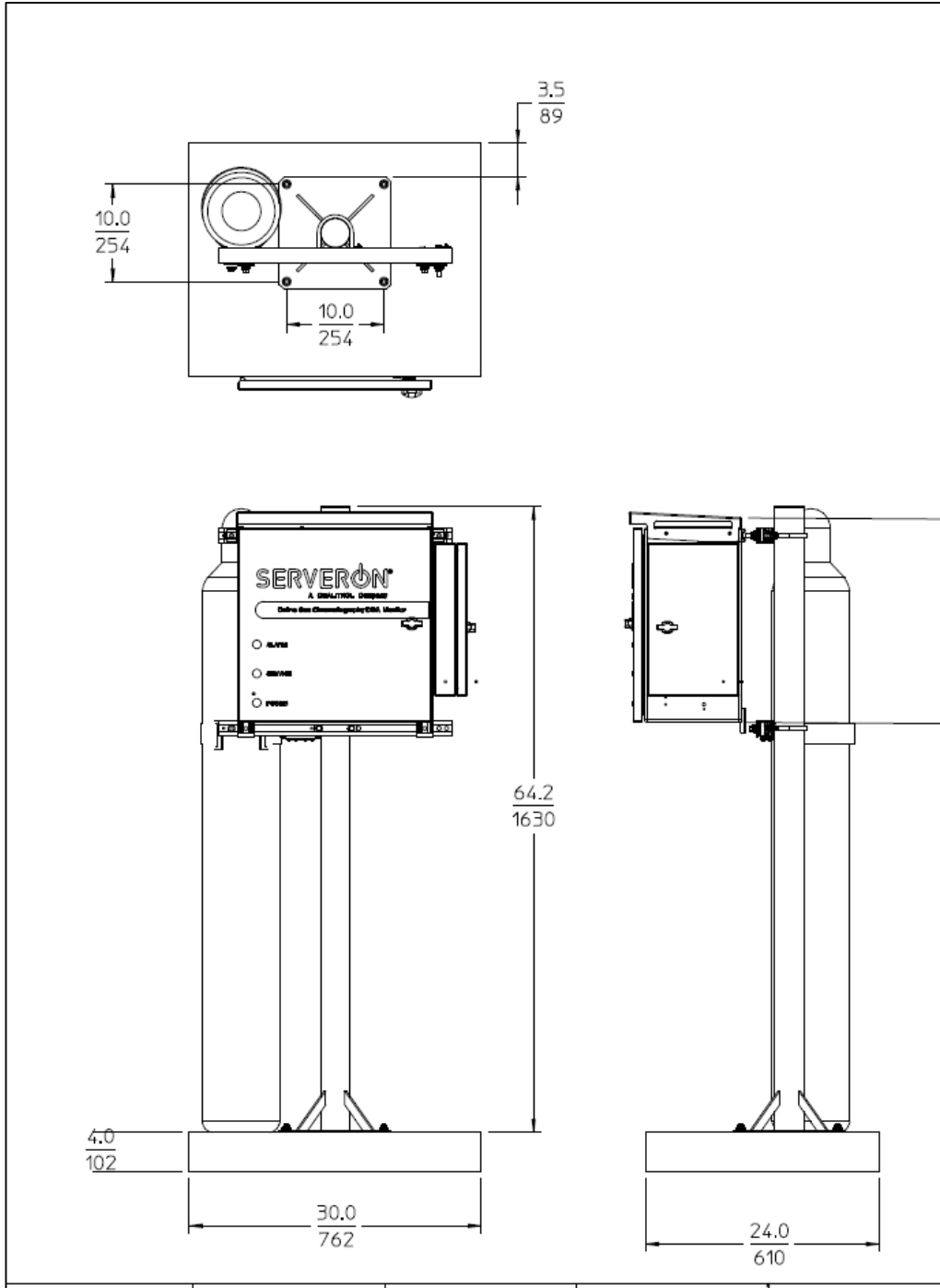

Figure 6: Concrete Pad Dimensions



Shipping Container Information

TMx Monitor

Shipping Weight: 90 lbs (41 kgs) – Stainless Steel

Dimensions: 27.5" x 25.5" x 16" (70 cm x 65 cm x 41 cm)

Accessory Kit

Shipping Weight: 44 lbs (20 kgs)

Dimensions: 27" x 27" x 13" (68 cm x 68 cm x 33 cm)

Oil Cooler (optional)

Shipping Weight: 18 lbs (8 kgs)

Dimensions: 25" x 25" x 6" (63 cm x 63 cm x 15 cm)

Pedestal Kit (if ordered)

Shipping Weight: 37 lbs (17 kgs)

Dimensions: 59" x 12" x 12" (150 cm x 30 cm x 30 cm)



Wiring Termination

Typical Wiring of the TMx with Integrated Junction Box: New Installation

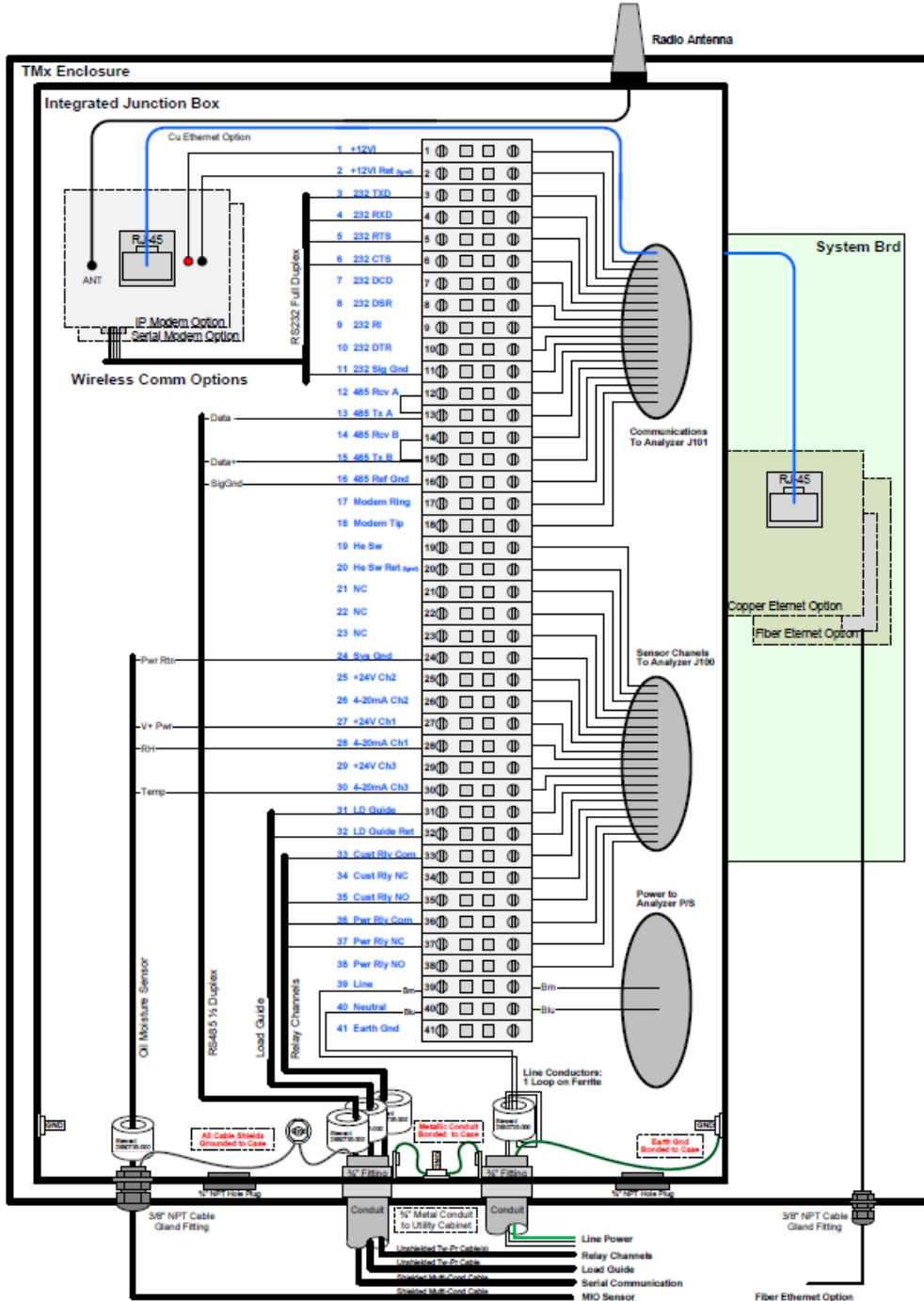

Figure 7: Wire Termination Diagram



Serveron® Field Services

Serveron provides on-site commissioning, start-up and comprehensive maintenance contracts to all customers worldwide. To further improve reliability, an extended warranty is available on selected products commissioned by Serveron.

Serveron® Educational Services

Serveron professional training (designed to achieve hands-on performance based objectives) prepares operations, maintenance, and engineering personnel to install, test, configure, operate and maintain Serveron products.

Serveron® Accelerated Delivery

Serveron provides accelerated delivery on many products and services including replacements, spare parts and repairs.

About Serveron®

Serveron transformer condition assessment and management tools are critical to utilities in improving grid reliability while optimizing the management and economics of their asset base. We are a leader in on-line DGA monitoring of power transformers with solutions across the entire power transformer fleet. Serveron is a QUALITROL Company.

© 2017 Serveron® Corporation. All rights reserved. Information subject to change without notice.

QUALITROL is a registered trademark of Qualitrol Company LLC. Serveron, LOADGUIDE, and TRUEGAS are registered trademarks and TM, TM2, TM3 and TM8 are trademarks of Serveron® Corporation.

All trademarks are properties of their respective companies, as noted herein. 810-1647-03 Rev B.